

Quick Start Guide

Smartphone cover

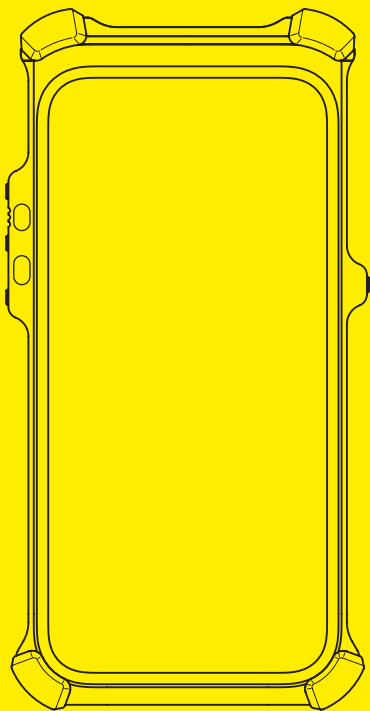

(xshielder)

Introduction

Thank you for choosing Xshielder.

This quick start guide has everything you need to set up and safely operate your new Xshielder smartphone cover.

The product consists in two main variants:

XS1-SP-G01-C01-**S01** / ***-*****-*-*-*: Removable lid* (flamepath)

XS1-SP-G01-C01-**S02** / ***-*****-*-*-*: Non-Removable lid (cemented)

S01 is a ATEX variant only. It has a Removable lid* so it's possible to access the device inside.

S02 version is ATEX and IECEx. It can not be opened.

The Xshielder smartphone cover is a flameproof Ex-d enclosure. It enables use of a smartphone in Zone 1 hazardous areas. The cover is made out of aluminium and strengthened glass.

Safety information



Warning!

- In the case of damage to the cover and/or glass windows, remove the device immediately from the hazardous area and bring it to a safe area.
- The cover must never be opened in hazardous areas where explosive atmospheres may be present. Doing so could pose serious safety risks!
- Avoid heat influences outside the specified temperature range!
- Battery charging is only allowed outside hazardous area!
- Read the specific conditions of use carefully!
- Opening the cover without authorization can void the Ex certification and will void the manufacturers product warranty, and any applicable product liability insurance. Always ensure that maintenance and modifications are performed in a safe and approved environment by personnel certified by Xshielder

* Removable Lid – Purpose & Guidelines

The Xshielder cover features a removable lid. It should only be opened by qualified personnel certified by Xshielder. Unauthorized access may compromise the integrity and safety of the device.

Removable lid allows for:

Easy replacement: In case of damage, the cover can be replaced without discarding the iPhone.

End-of-Life Management: When the product reaches the end of its lifecycle, the iPhone can be extracted for recycling, reuse, or trade-in for a newer model.

In the box

1. Xshielder cover with iPhone 16 Pro Max
2. Xshielder quick start guide
3. Apple iPhone 16 Pro Max quick start guide

Wireless charger is not included and must be purchased separately. While many wireless chargers will work, the product is designed with the Apple MagSafe Charger in mind. If using another charger, ensure it fits within the glass opening in the chassis. **Do not charge in hazardous areas!**

Product overview

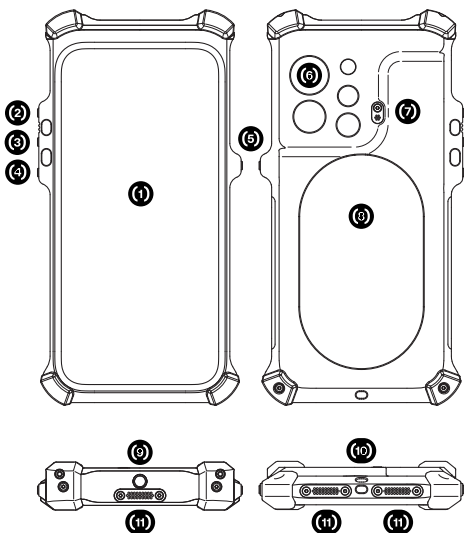

- | | |
|---|---------------------------|
| 1. Display glass (Gorilla Glass) | 7. Mic. |
| 2. Programmable key | 8. Wireless charging area |
| 3. Volume up | 9. 1/4" thread |
| 4. Volume down | 10. Lanyard mount |
| 5. Power key | 11. Speaker/Mic. |
| 6. Camera array (3x camera, Lidar, Flash) | |

Recommended audio settings

For best possible audio performance it is crucial to enable *Voice Isolation mode*. This will reduce internal audio reflections inside the cover (echo). This works for both phone calls but also other voice/video conferencing apps like teams.

1) During your call, swipe down from the top-right corner of your screen to open Control Center.

2) Tap [App] Controls.



3) Under Audio & Video, select a Mic Mode: Voice Isolation.

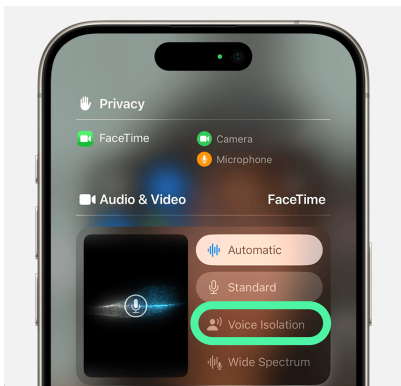

Recommended touch settings

For optimal performance and to maintain tactile feedback while using your iPhone in an Xshielder cover, it is recommended to turn on keyboard haptics. This will provide a subtle vibration with each key press, ensuring accurate typing.

1) Open the Settings app.

2) Go to Sounds & Haptics > Keyboard Feedback.

3) Turn Haptic on or off.

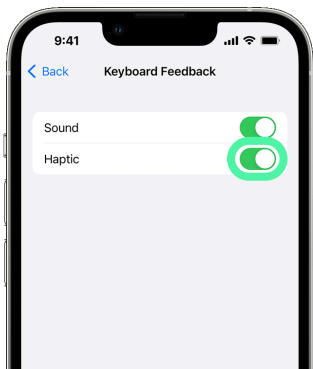

Turning on keyboard haptics might affect the battery life of your iPhone.

If you turn on keyboard haptics but you don't feel haptics when you type, make sure that Vibration is turned on in Settings > Accessibility > Touch.

Technical data

ATEX marking: XS1-SP-G01-C01-S01 / ***-*****-*-*-* (Removable Lid, flamepath) XS1-SP-G01-C01-S02 / ***-*****-*-*-* (Non-Removable Lid, cemented)	
EX marking	 II 2G Ex db IIC T6 Gb II 2D Ex tb IIIC T80°C Db Tamb -20°C to +50°C
ATEX Certificate nr	FIDI 24 ATEX 0075X
Standards	EN IEC 60079-0:2018 EN 60079-1:2014 EN 60079-31:2014

IECEX marking: XS1-SP-G01-C01-S02 / ***-*****-*-*-* (Non-removable lid, cemented)	
EX marking	Ex db IIC T6 Gb Ex tb IIIC T80°C Db Tamb -20°C to +50°C
IECEX Certificate nr	IECEX FIDI 24.0017X
Standards	IEC 60079-0: 2017 IEC 60079-1: 2014 IEC 60079: 31:2013

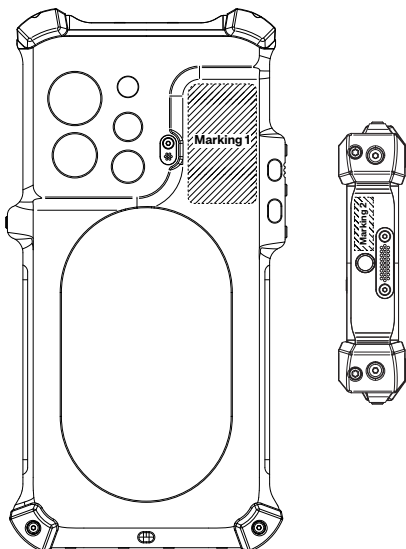

Spec.	
Supported phone model	iPhone 16 Pro Max
Size:	187 x 93 x 17.6 mm*
Weight (including phone)	415g
Operating temperature	-20 °C to +50 °C
Storage temperature	-20 °C to +60 °C
Charging temperature	0 °C to +40 °C
Operating temp. iPhone	Refer to iPhone manual
Hardware/Software spec.	Refer to iPhone manual
RF	Refer to iPhone manual. Due to the material used and rugged nature of the cover, the RF characteristics might not be similar to the smartphone inside
Electrical data:	Battery supply: 3.9V Nom.

Device marking



Type:
XS1-SP-G01-C01-S01 / ***-*****-***

Marking 1 - back of chassis

 2460 

 II 2G Ex db IIC T6 Gb
 II 2D Ex tb IIIC T80°C Db
 Tamb -20°C to +50°C

Type nr: XS1-SP-G01-C01-S01
ATEX: FIDI 24 ATEX 0075X

Mfr: Xshielder
Badehusgata 37
4014 Stavanger, Norway

**WARNING: Do not charge
the device in hazardous location**



S/N: G01YSSSSSS 

Marking 2 - top of lid

WARNING:
Do not open lid!

Type:
XS1-SP-G01-C01-S02 / ***-*****-***

Marking 1 - back of chassis

 2460 

 II 2G Ex db IIC T6 Gb
 II 2D Ex tb IIIC T80°C Db
 Tamb -20°C to +50°C

Type nr: XS1-SP-G01-C01-S02
ATEX: FIDI 24 ATEX 0075X
IECEX: IECEx FIDI 24.0017X

Mfr: Xshielder
Badehusgata 37
4014 Stavanger, Norway

**WARNING: Do not charge
the device in hazardous location**

S/N: G01YSSSSSS 

Marking 2 - top of lid

no marking

Maintenance, service & Inspection

- Maintenance, service and inspections need to be carried out according to IEC/ EN 60079-17 and IEC/EN 60079-19.
- Opening/closing of the Lid on -S01 version needs to be carried out by qualified personell only. Opening of version S02 is not allowed by user.
- Do not use cleaning agents to clean the cover. Use a damp cloth
- Fasteners must only be replaced by identical type (check Specific Condition of Use). Contact Xshielder AS for spare parts.
- Repair of flameproof joints is not allowed according to IEC 60079-1 values.

Specific condition of use

- A repair of flameproof joints is not allowed according to EN/IEC 60079-1 values.
- Fasteners shall only be replaced with identical ones. The minimum tensile strength must be 500 MPa.
- Smartphone is tested for low impact energy and shall not be exposed to high impact risk.
- The smartphone cover (Ex-d enclosure) shall not be opened in hazardous area.
- Opening of version XS1-SP-G01-C01-S02 / ***-*****-*-*-* is not allowed by the user.
- Battery charging is only allowed outside hazardous area.

FAQ

Scan QR code for FAQ section on:
www.xshielder.com/FAQ



Disclaimer

Xshielder provides only the Ex cover and does not supply or assume any responsibility for the enclosed iPhone. Any issues related to the iPhone, including functionality, performance, or warranty, are the sole responsibility of the phone manufacturer or supplier.

Xshielder provides information about iPhone compatibility and usage based on publicly available Apple guidelines. However, we are not responsible for Apple product support, software issues, or hardware functionality outside of our cover. For official guidance, troubleshooting, or warranty concerns related to your iPhone, please contact your Apple Reseller or Apple Support directly.